

**Dijets with a large rapidity separation
for search of gravity with large extra dimensions
in the trans-Planckian eikonal regime**

**ANATOLII Iu. EGOROV , VICTOR T. KIM,
VADIM A. ORESHKIN, VICTOR A. MURZIN**

**Petersburg Nuclear Physics Institute
NRC "Kurchatov Institute"**

[\[Phys. Rev. D 113 \(2026\) 035038\]](#)



Outline

- BFKL evolution vs GLAPD evolution of QCD
- Mueller-Navelet dijets
- First direct evidence of BFKL evolution in pp collisions at 2.76 TeV by CMS at LHC
- Gravity with large extra dimensions as an example of possible new physics
- Predictions
- Summary

GLAPD

Gribov—Lipatov—Altarelli—Parisi—Dokshitzer

Bjorken limit

$$\sqrt{s} \rightarrow \infty; p_T \rightarrow \infty; x \sim \frac{p_T}{\sqrt{s}} \sim 1$$

$$k_{Tn} \gg k_{Tn-1} \gg \dots \gg k_{T2} \gg k_{T1}$$

$$p_T \sim Q^2 \quad \Sigma_n [\alpha_s \log Q^2]^n$$

GLAPD evolution

$$\frac{df_i}{d \log \mu^2} = \frac{\alpha_s}{2\pi} [P_{qq} \otimes f_i + P_{qg} \otimes f_g]$$

$$\frac{df_g}{d \log \mu^2} = \frac{\alpha_s}{2\pi} [P_{gq} \otimes \sum_i f_i + P_{gg} \otimes f_g]$$

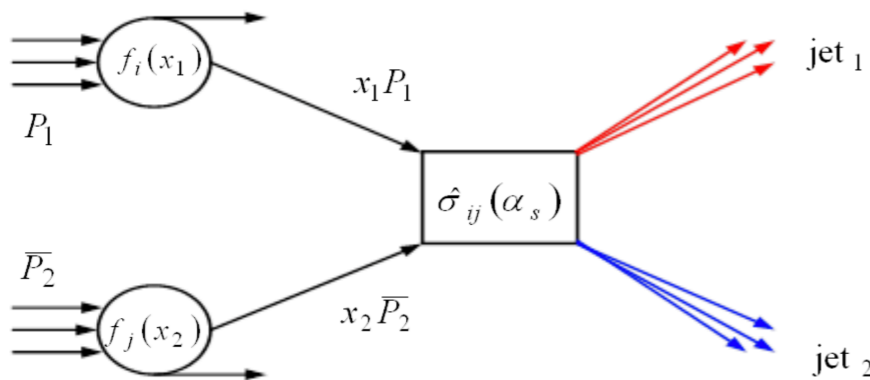

VS

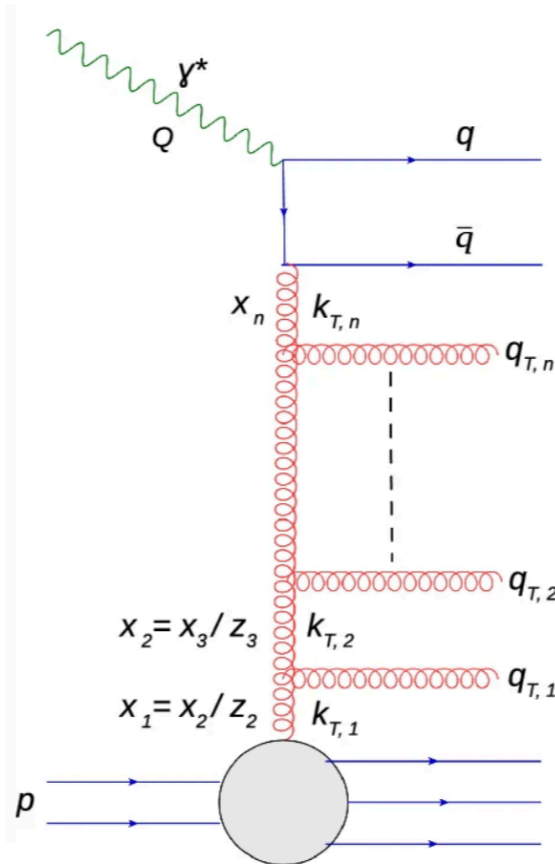

BFKL

Balitsky—Fadin—Kuraev—Lipatov

BFKL kinematics (LLA): Gribov-Regge limit

$$\sqrt{s} \rightarrow \infty; p_T - \text{finite}; x \sim \frac{p_T}{\sqrt{s}} \rightarrow 0;$$

with $p_T \gg \Lambda_{QCD}$

$$x_n \gg x_{n-1} \gg \dots \gg x_2 \gg x_1$$

$$k_{Tn} \sim k_{Tn-1} \sim \dots \sim k_{T2} \sim k_{T1}$$

$$\Sigma_n [\alpha_s \log(1/x)]^n$$

BFKL evolution

$$\frac{\partial f_g}{\partial \log 1/x} = K \otimes f_g = \omega f_g \Rightarrow$$

$$f_g \sim \left(\frac{1}{x}\right)^\omega \sim \left(\frac{s}{s_0}\right)^\omega \sim e^{\omega \Delta y}$$

$$\omega_{\max} = \alpha_P(0) - 1$$

LL BFKL provides too large intercept

$$\alpha_P^{LL}(0) \approx 1.5$$

$$\text{NLL BFKL: } \alpha_P^{NLL} \approx 1.2$$

S.J. Brodsky, V.S. Fadin, V.T. Kim,

L.N. Lipatov, G.B. Pivovarov

[JETP Lett. 70 (1999) 155-160]

Mueller-Navelet (most forward/backward) dijets

A. H. Mueller and H. Navelet [[Nucl. Phys. B 282 \(1987\) 727](#)]

$$\sqrt{s} = 2.76 \text{ TeV}$$

$$p_{T\text{min}} = 35 \text{ GeV}$$

$$\Delta y < 9.4$$

CMS [[JHEP03\(2022\)189](#)]

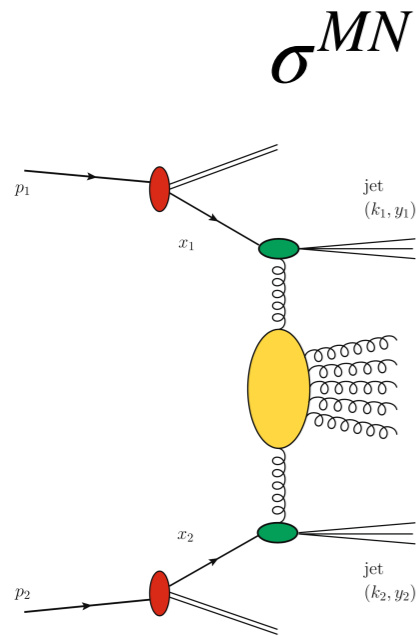

MN dijet is a pair of jets with $p_T > p_{T\text{min}}$
most separated in rapidity $\Delta y = |y_1 - y_2|$

GLAPD-based generators (justified at small Δy):

- PYTHIA8 - LO + LL GLAPD+ Color coherence
- HERWIG - LO + LL GLAPD+ Color coherence
- POWHEG - NLO

BFKL-based generator (valid at $\Delta y \gg 1$):

- HEJ+ARIADNE - LL BFKL

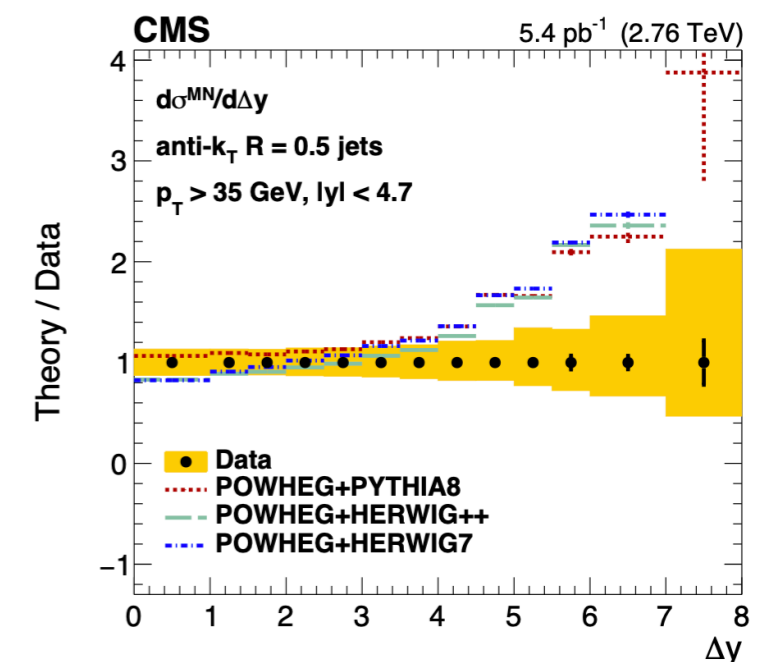
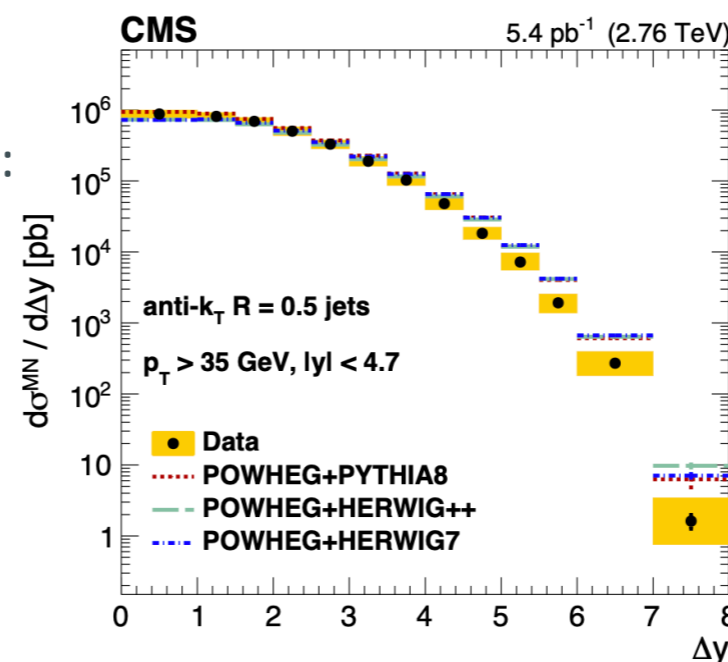
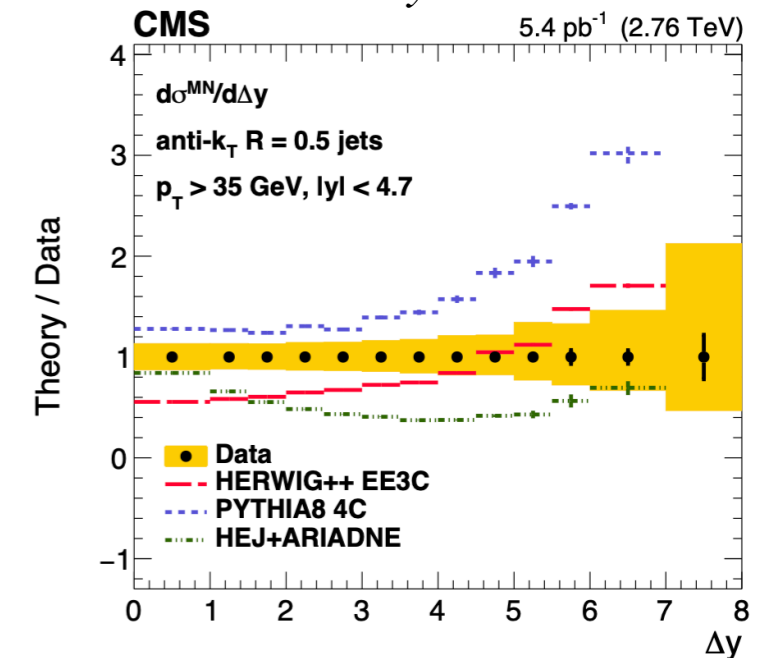
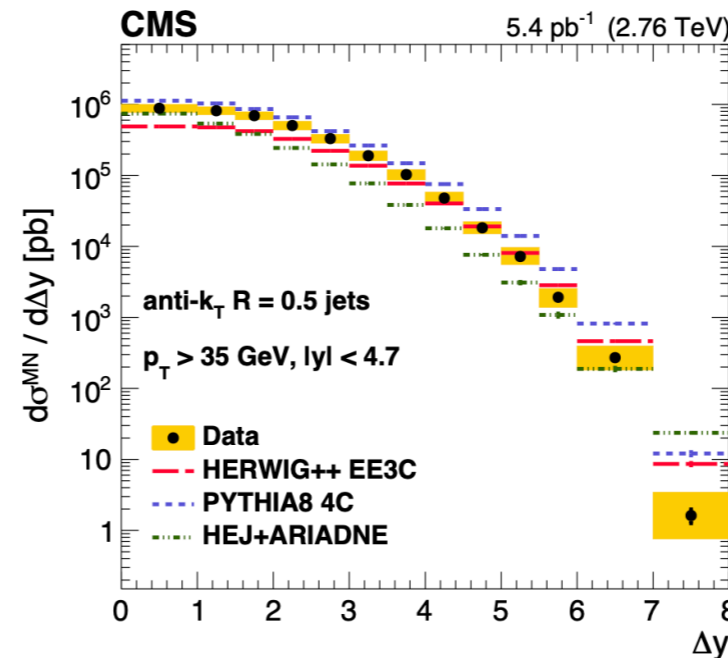



First comparison: NLL BFKL for MN dijets @ 2.76 TeV

NLL BFKL dijets: A. Iu. Egorov and V. T. Kim [[Phys. Rev. D 108 \(2023\) 014010](#)]

CMS data 2.76 TeV [[JHEP03\(2022\)189](#)]

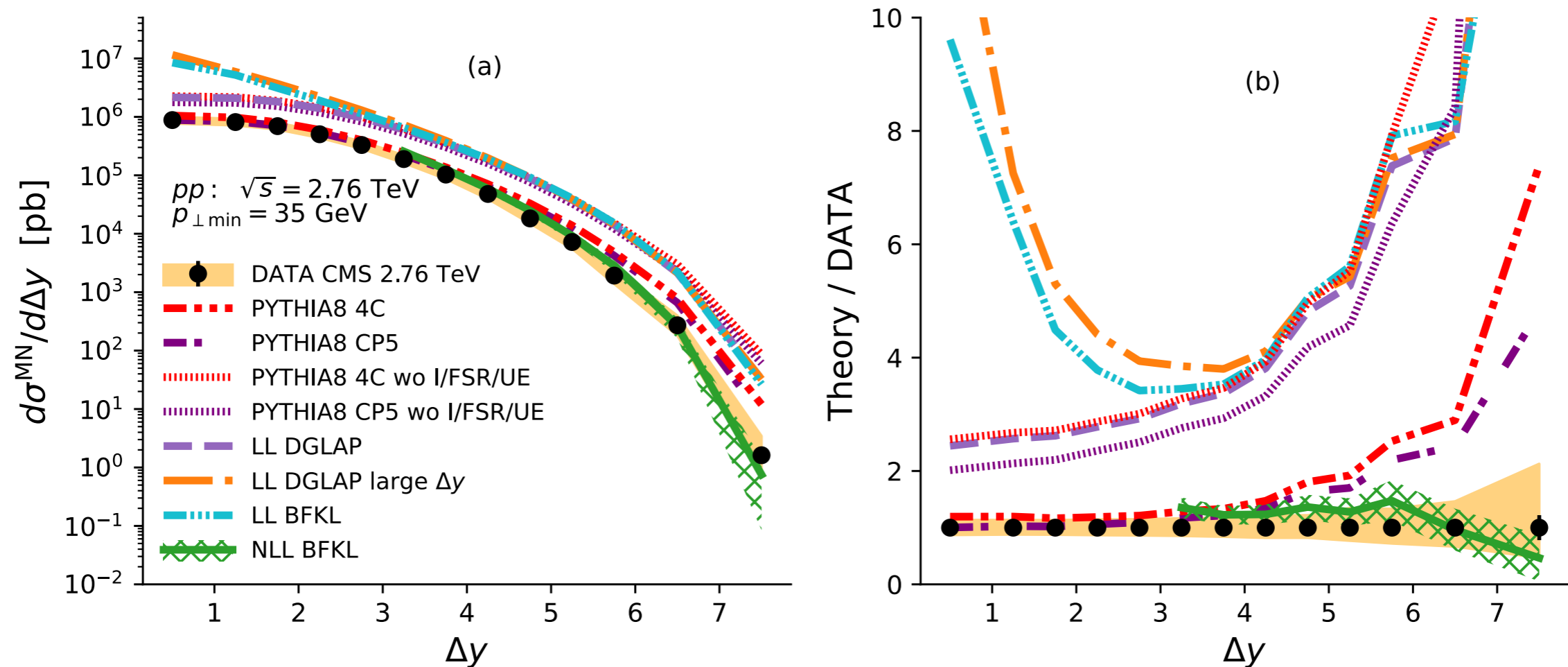

- MN dijet cross section: NLL BFKL agrees with the CMS data at large Δy
- The all other calculations based on LO/NLO+LL DGLAP overestimates the CMS data at large Δy (analytical LL DGLAP, PYTHIA8, HERWIG, POWHEG)



Example of possible new physics: Gravity with large extra dimensions

N. Arkani-Hamed, S. Dimopoulos, G. Dvali (ADD) [[Phys. Lett. B 429 \(1998\) 263-272](#)]

$$V(r) \sim \frac{m_1 m_2}{M_{Pl(4+n)}^{n+2}} \frac{1}{r^{n+1}} \quad (r \ll R)$$

$$V(r) \sim \frac{m_1 m_2}{M_{Pl(4+n)}^{n+2} R^n} \frac{1}{r} \quad (r \gg R)$$

$$M_{Pl}^2 \sim M_{Pl(4+n)}^{2+n} R^n$$

If

$$M_{Pl(4+n)} \sim m_{EW}$$

Then

$$R \sim 10^{\frac{30}{n}-17} \text{cm} \times \left(\frac{1 \text{TeV}}{m_{EW}} \right)^{1+\frac{2}{n}}$$



Kaluza-Klein excitations of the graviton

G.F. Giudice, R. Rattazzi, J.D. Well [[Nucl. Phys. B 544 \(1999\) 3-38](#)]

let's denote $M_{Pl(4+n)} = M_D$

$$\mathcal{R}_{AB} - \frac{1}{2} g_{AB} \mathcal{R} = - \frac{T_{AB}}{M_D^{2+n}}$$

$$g_{AB} = \eta_{AB} + 2M_D^{1-\frac{n}{2}} h_{AB}$$

$$\square h_{AB} - \partial_A \partial^C h_{CB} - \partial_B \partial^C h_{CA} + \partial_A \partial_B h_C^C - \eta_{AB} \square h_C^C + \eta_{AB} \partial^C \partial^D h_{CD} = - M_D^{-1-\frac{n}{2}} T_{AB}$$

If

$$z(x, y) \rightarrow (x_0, \mathbf{x}, y_1, \dots, y_n); \quad y_j = y_j + 2\pi R, \quad j = 1, \dots, n$$

Then

$$h_{AB}(z) = \sum_{n_1=-\infty}^{\infty} \dots \sum_{n_n=-\infty}^{\infty} \frac{h_{AB}^{(n)}(x)}{\sqrt{(2\pi R)^n}} e^{i \frac{n_j y_j}{R}} \quad T_{AB}(z) = \eta_A^\mu \eta_B^\nu T_{\mu\nu} \delta(y)$$

Trans-Planckian eikonal regime (1)

G.F. Giudice, R. Rattazzi, J.D. Well [Nucl. Phys. B 630 (2002) 293-325]

$s \gg M_D^2$ - Trans-Planckian
 $s \gg |t|$ - eikonal

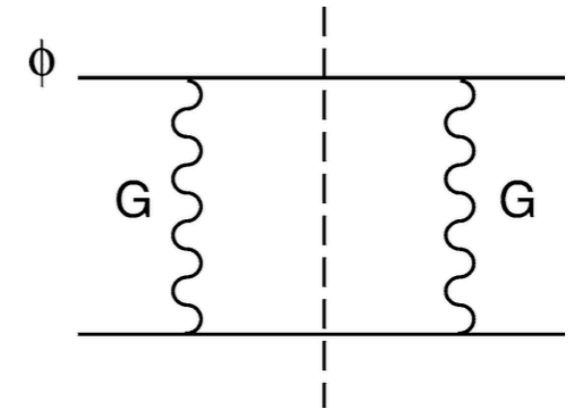
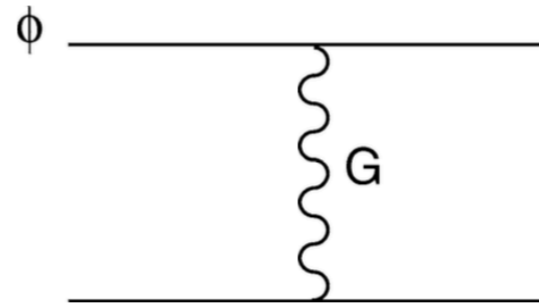

$$\mathcal{A}_{\text{Born}}(-t) = \frac{s^2}{M_D^{n+2}} \int \frac{d^n q_T}{t - q_T^2} = \pi^{n/2} \Gamma(1 - n/2) \left(\frac{-t}{M_D^2} \right)^{\frac{n}{2}-1} \left(\frac{s}{M_D^2} \right)^2$$

$$\mathcal{A}_{1\text{-loop}}(-q^2) = \frac{i}{4s} \int \frac{d^2 k_\perp}{(2\pi)^2} \mathcal{A}_{\text{Born}}[k_\perp^2] \mathcal{A}_{\text{Born}}[(q_\perp - k_\perp)^2]$$

$$\mathcal{A}_{\text{eik}} = \mathcal{A}_{\text{Born}} + \mathcal{A}_{1\text{-loop}} + \dots = -2is \int d^2 b_\perp e^{iq_\perp b_\perp} (i\chi - \frac{1}{2}\chi^2 + \dots) = -2is \int d^2 b_\perp e^{iq_\perp b_\perp} (e^{i\chi} - 1)$$

$$\chi(b_\perp) = \frac{1}{2s} \int \frac{d^2 q_\perp}{(2\pi)^2} e^{-iq_\perp b_\perp} \mathcal{A}_{\text{Born}}(q_\perp^2)$$

$$\frac{d\sigma_{\text{eik}}}{dt} = \frac{|\mathcal{A}_{\text{eik}}|^2}{16\pi s^2}$$

Trans-Planckian eikonal regime (2)

G.F. Giudice, R. Rattazzi, J.D. Well [[Nucl. Phys. B 630 \(2002\) 293-325](#)]

In proton-proton collisions

$$\hat{s} = M_{jj} \gg M_D^2 \quad \text{- Trans-Planckian}$$

$$\hat{s} \gg |\hat{t}| \quad \text{- eikonal}$$

$$\exp\{\Delta y\} \approx \frac{\hat{s}}{|\hat{t}|}$$

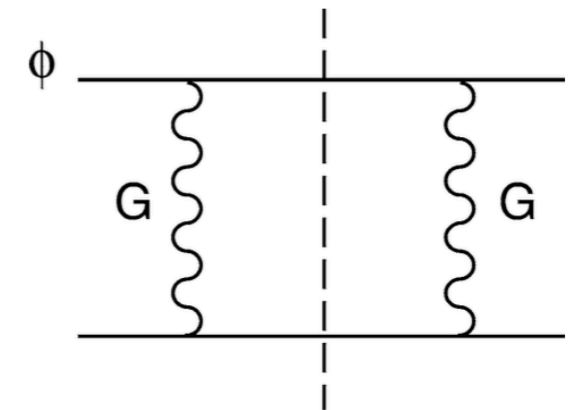
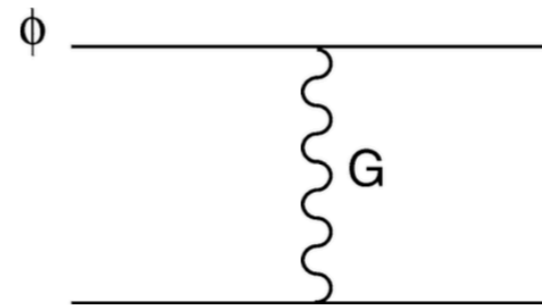

- High- M_{jj} dijets with large rapidity separation are the signal of Large Extra Dimension Gravity

- QCD is the main source of the background

- NLL BFKL is a right tool for the background estimation

Dijets with large Δy @ $\sqrt{s} = 13$ TeV

$p_{\perp \min} > 20$ GeV
 $|y| < 4.7$

$M_{jj} > 6$ TeV

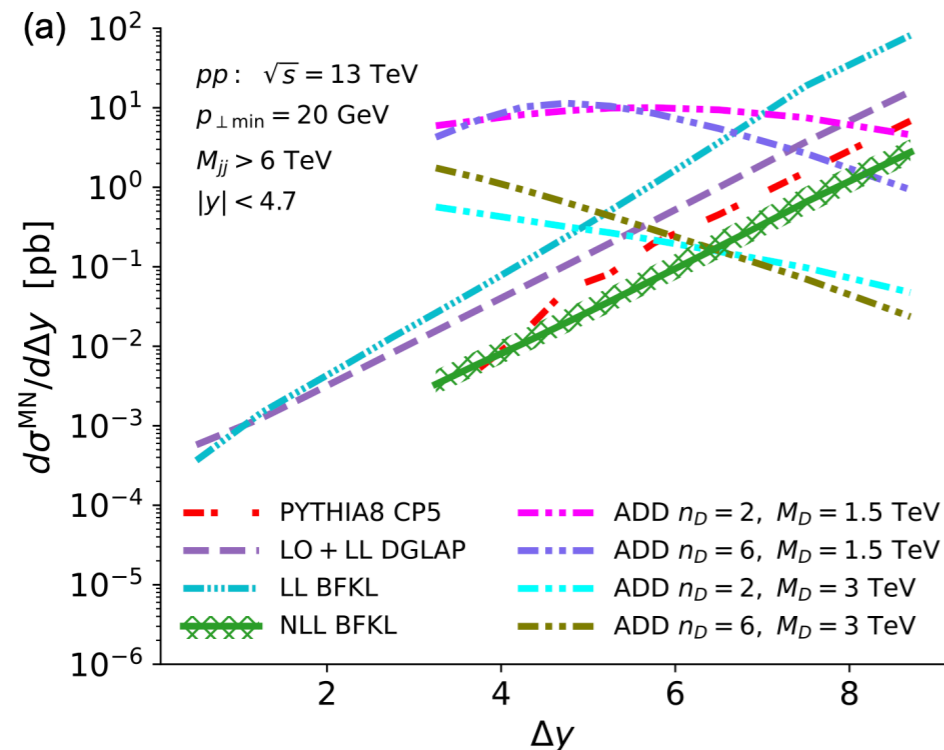

$$\frac{\hat{t}}{|\hat{s}|}(\Delta y = 4) \approx 0.018$$

$$\frac{\hat{t}}{|\hat{s}|}(\Delta y = 8) \approx 0.00034$$

- Large statistics is needed for large Δy (Experiment difficultly)
- GLAPD overestimates background x10 times at large Δy
- BFKL predicts stronger suppression under M_{jj} selection than GLAPD
- Sensitivity to ADD gravity up to $M_D \sim 3$ TeV

A. Iu. E., V. T. Kim, V.A. Murzin, V.A. Oreshkin [[Phys. Rev. D 113 \(2026\) 035038](https://arxiv.org/abs/2508.12345)]

$M_{jj} > 9$ TeV

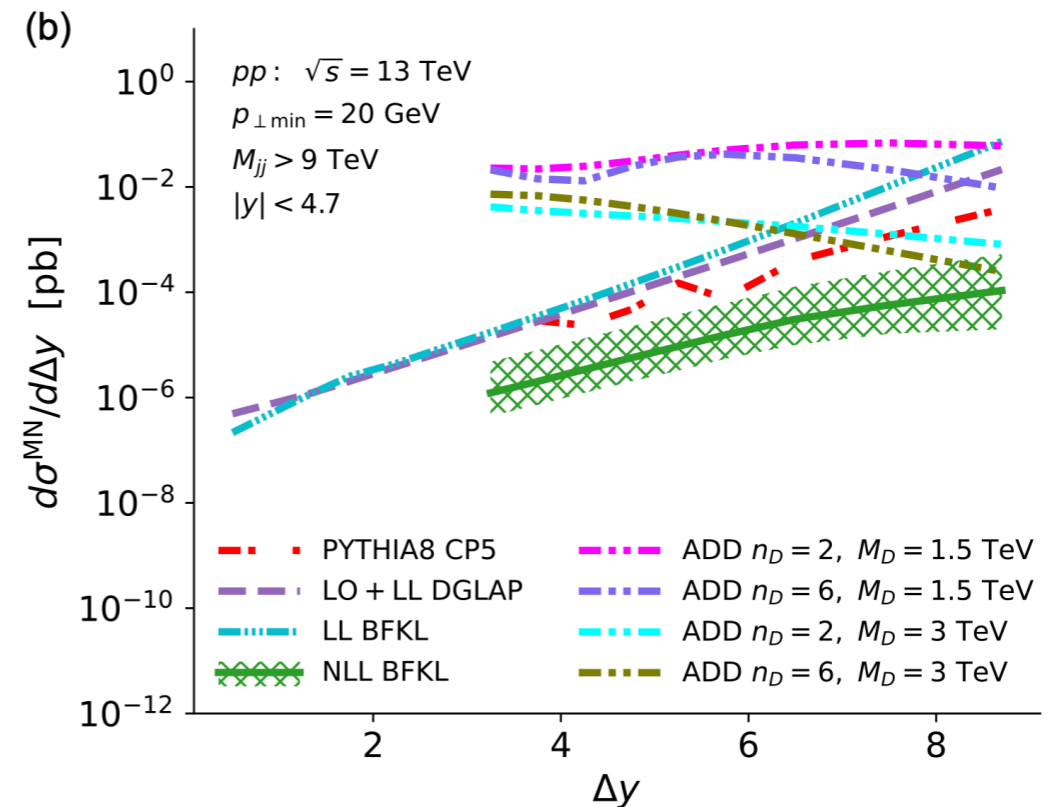

Dijets with large Δy @ $\sqrt{s} = 40$ TeV

$p_{\perp \min} > 20$ GeV
 $|y| < 4.7$

$M_{jj} > 9$ TeV

A. Iu. E., V. T. Kim, V.A. Murzin, V.A. Oreshkin [[Phys. Rev. D 113 \(2026\) 035038](https://arxiv.org/abs/2508.12345)]

$M_{jj} > 30$ TeV

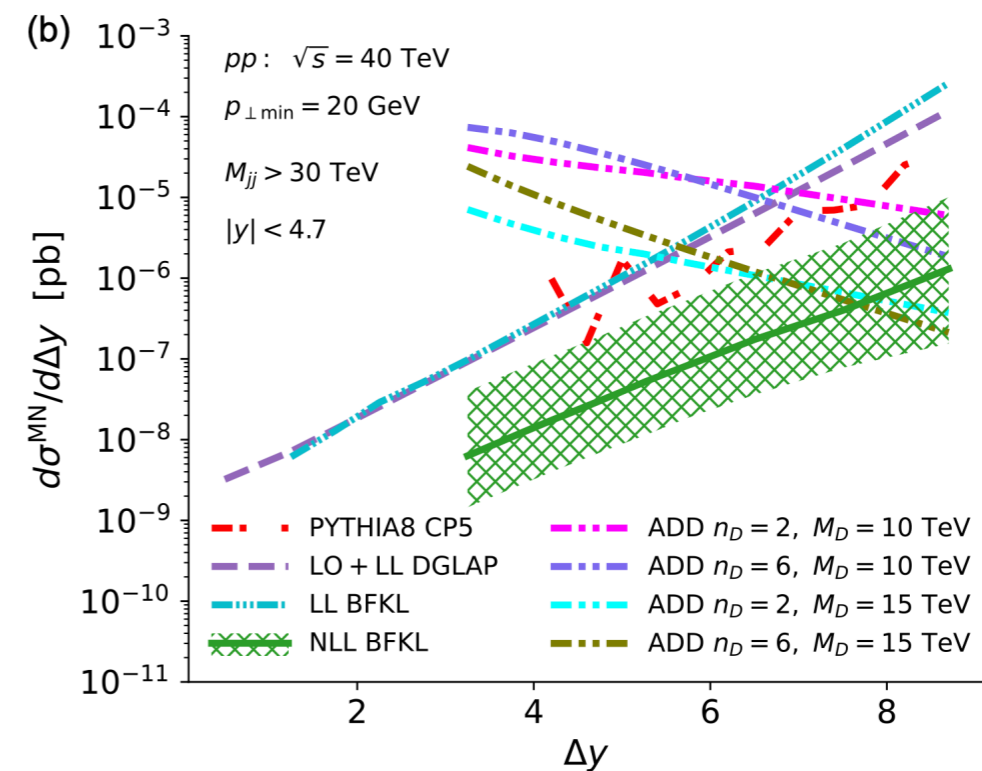
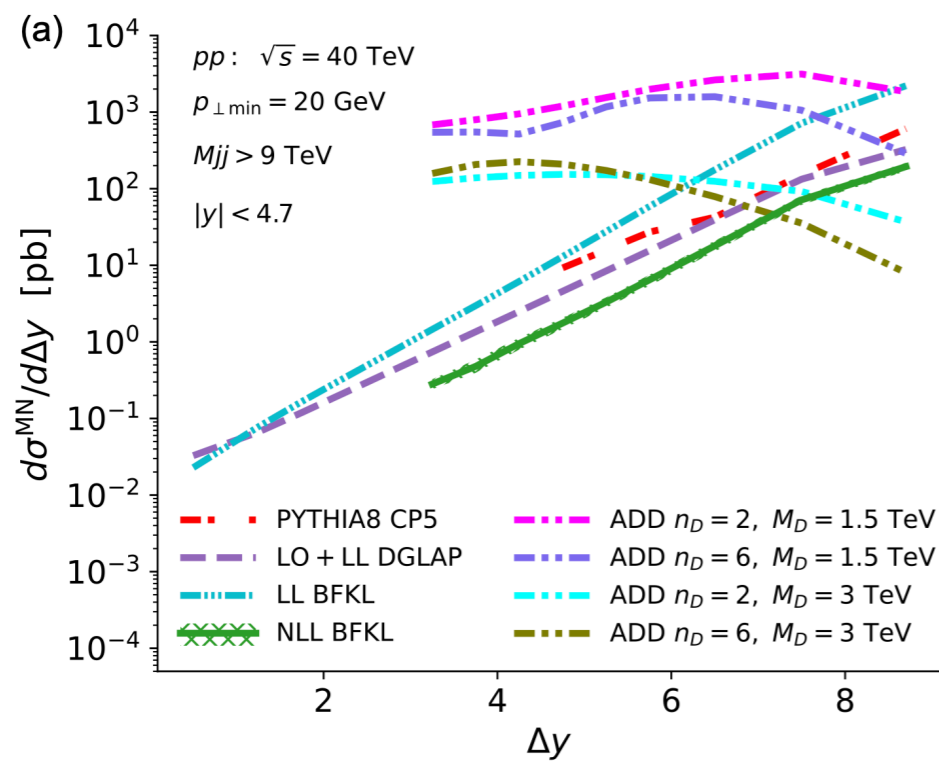

- PYTHIA 8 is about LL GLAPD analytical calculation
- PYTHIA 8: It is difficult to get statistics for large M_{jj}
- GLAPD overestimates background 100 times at large Δy and $M_{jj} > 30$ GeV
- BFKL predicts stronger suppression under M_{jj} selection than GLAPD
- Sensitivity to ADD gravity up to $M_D \sim 10$ TeV

Dijets with large Δy @ $\sqrt{s} = 100$ TeV

$p_{\perp \min} > 20$ GeV
 $|y| < 4.7$

A. Iu. E., V. T. Kim, V.A. Murzin, V.A. Oreshkin [[Phys. Rev. D 113 \(2026\) 035038](https://arxiv.org/abs/2508.12345)]

$M_{jj} > 30$ TeV

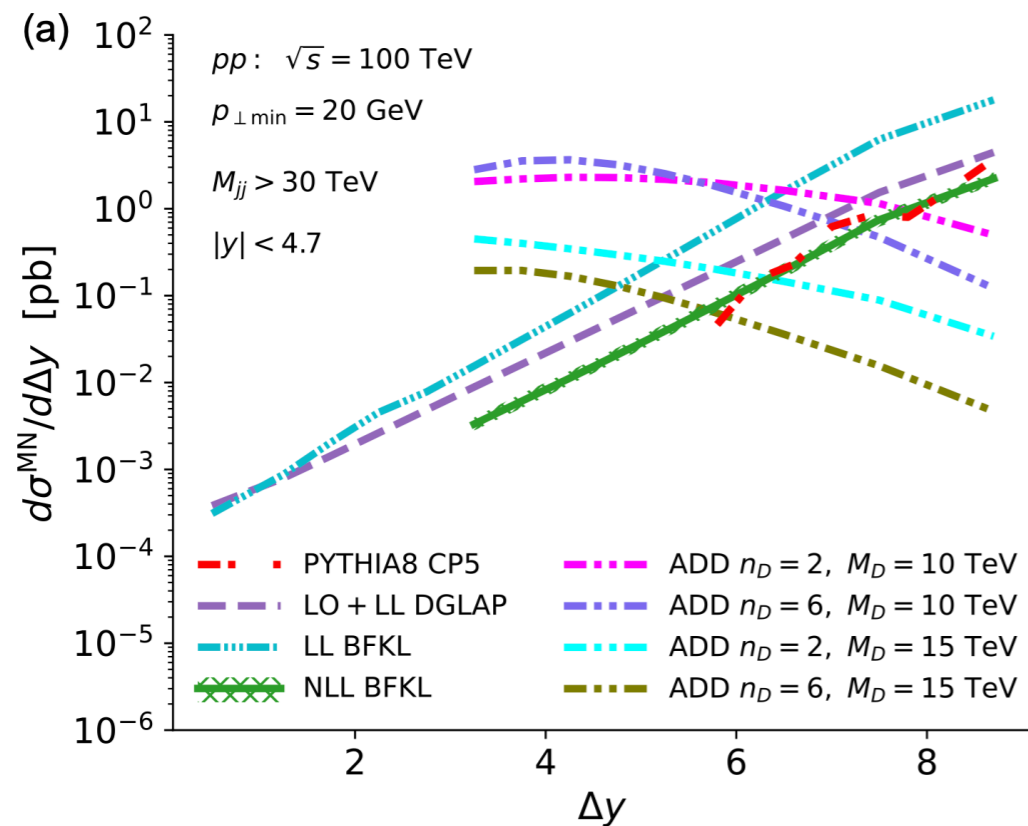

$M_{jj} > 70$ TeV

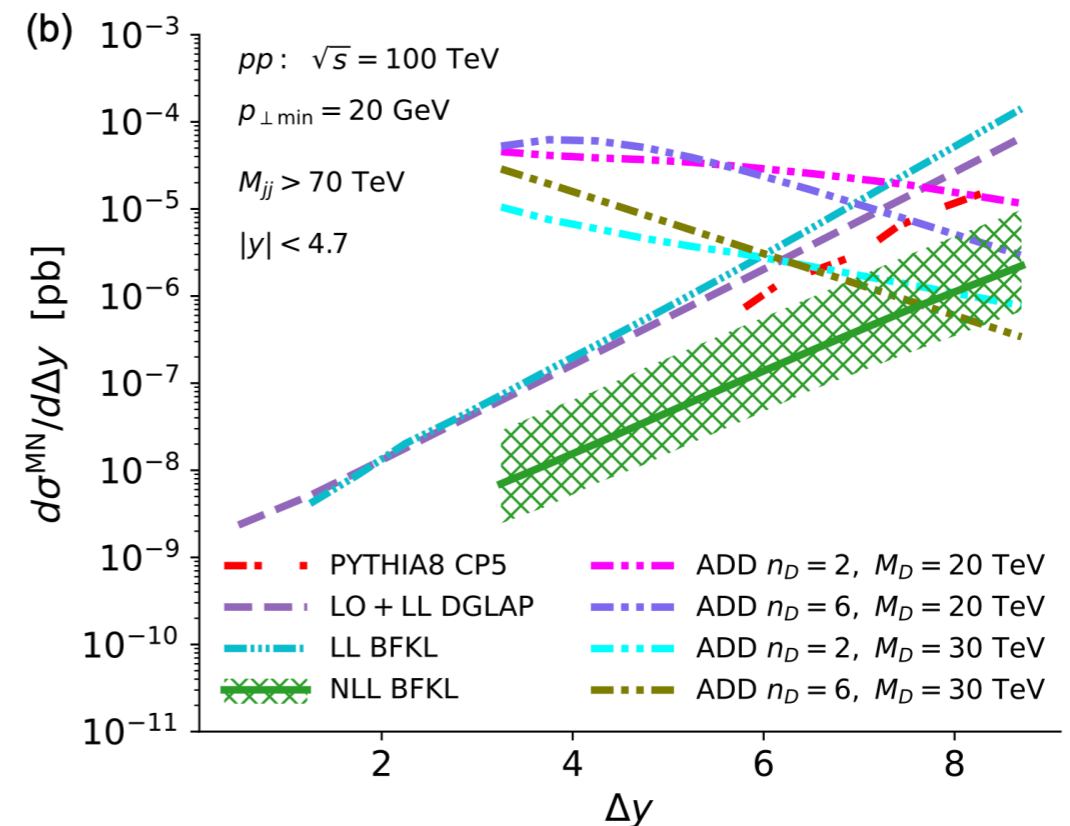

- GLAPD overestimates background x100 times at large Δy and large M_{jj}
- BFKL predicts stronger suppression under M_{jj} selection than GLAPD
- Sensitivity to ADD gravity up to $M_D \sim 20$ TeV

Summary

- NLL BFKL evolution is the right tool for QCD at large Δy . So possible new physics is the signal above BFKL QCD background at large Δy
- Dijet production with large Δy and M_{jj} is sensitive to signals of gravity with large extra dimensions in trans-Planckian eikonal regime
- NLL BFKL predicts less background QCD events than more conventional GLAPD evolution at large Δy and M_{jj} (up to two orders in amount of events). The BFKL evolution is more sensitive to M_{jj} selection than the GLAPD evolution.
- large experimental luminosity is needed (up to ~ 1000 fb) for searches of new physics at large Δy . So high-granularity detectors which are able to disentangle large pileup events at large rapidities are needed
- More precise measurements of the proton structure functions at $x \rightarrow 1$ are highly desirable

THANK YOU!

NLL BFKL for MN dijets

$$\frac{d\sigma}{dy_1 dy_2 d^2\vec{p}_{T1} d^2\vec{p}_{T2}} = \sum_{ij} \int f_i(x_1, \mu_F) f_j(x_2, \mu_F) \frac{d\hat{\sigma}_{ij}(x_1 x_2 s, \mu_F, \mu_R)}{dy_1 dy_2 d^2\vec{p}_{T1} d^2\vec{p}_{T2}}$$

Large Δy : $f^{\text{eff}}(x, \mu_F) = \frac{C_A}{C_F} f_g(x, \mu_F) + \sum_{i=q, \bar{q}} f_i(x, \mu_F)$

NLL BFKL

$$\begin{aligned} \frac{d\hat{\sigma}_{gg}}{dy_1 dy_2 d^2\vec{p}_{T1} d^2\vec{p}_{T2}} &= \frac{x_{J1} x_{J2}}{(2\pi)^2} \int \frac{d^2\vec{q}_1}{\vec{q}_1^2} V_1(\vec{q}_1, x_1, \vec{p}_{T1}, x_{J1}) \\ &\times \int \frac{d^2\vec{q}_2}{\vec{q}_2^2} V_2(-\vec{q}_2, x_2, \vec{p}_{T2}, x_{J2}) \\ &\times \int_C \frac{d\omega}{2\pi i} \left(\frac{x_1 x_2 s}{s_0} \right)^\omega G_\omega(\vec{q}_1, \vec{q}_2), \end{aligned}$$

$$\Phi(\vec{q}, \vec{p}_T, x_J, \omega) \equiv \sum_i \int_0^1 dx f_i(x, \mu_F) \left(\frac{x}{x_J} \right)^\omega V_i(\vec{q}, x, \vec{p}_T, x_J),$$

$$\Phi_{1,2}(n, \nu, \vec{p}_{T1,2}, x_{J1,2}, \omega) = \alpha_s(\mu_R) [c_{1,2}(n, \nu) + \bar{\alpha}_s(\mu_R) c_{1,2}^{(1)}(n, \nu)]$$

$$\frac{d\sigma}{dy_1 dy_2 d|\vec{p}_{T1}| d|\vec{p}_{T2}| d\phi_1 d\phi_2} = \frac{1}{(2\pi)^2} \left[\mathcal{E}_0 + \sum_{n=1}^{\infty} 2 \cos(n\phi) \mathcal{E}_n \right]$$

F. Caporale, D. Yu. Ivanov, B. Murdaca & A. Papa

[[Phys. Rev. D 91 \(2015\) 114009](#)]

D. Colferai, F. Schwennsen, L. Szymanowski & S. Wallon

[[JHEP12\(2010\)026](#)]

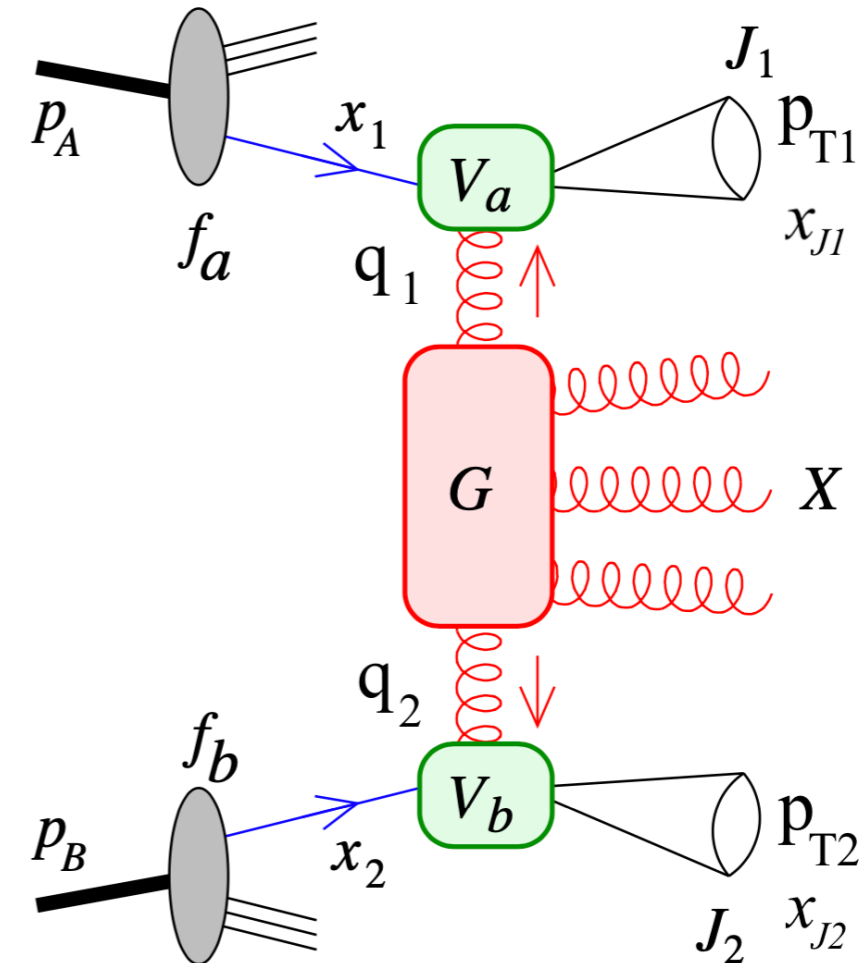

Generalized BLM optimal scale setting

Brodsky-Fadin-Kim-Lipatov-Pivovarov (BFKL)

[[JETP Lett. 70 \(1999\) 155-160](#)]

NLL BFKL for MN dijets

NLL BFKL

$$\frac{d\sigma}{dy_1 dy_2 d|\vec{p}_{T1}| d|\vec{p}_{T2}| d\phi_1 d\phi_2} = \frac{1}{(2\pi)^2} \left[\mathcal{C}_0 + \sum_{n=1}^{\infty} 2 \cos(n\phi) \mathcal{C}_n \right]$$

$$\mathcal{C}_n = \frac{x_{J1} x_{J2}}{|\vec{p}_{T1}| |\vec{p}_{T2}|} \int_{-\infty}^{+\infty} d\nu e^{(Y-Y_0) \bar{\alpha}_s(\mu_R) \chi(n, \nu)} \alpha_s^2(\mu_R) c_1(n, \nu) c_1(n, \nu) \left[1 + \bar{\alpha}_s(\mu_R) \left(\frac{\bar{c}_1^{(1)}(n, \nu)}{c_1(n, \nu)} + \frac{\bar{c}_2^{(1)}(n, \nu)}{c_2(n, \nu)} \right. \right. \\ \left. \left. + \frac{\beta_0}{2N_c} \left(\frac{5}{3} + \ln \frac{\mu_R^2}{|\vec{p}_{T1}| |\vec{p}_{T2}|} \right) \right) \right] + \bar{\alpha}_s^2(\mu_r) \ln \frac{x_{J1} x_{J2} s}{s_0} \left\{ \bar{\chi}(n, \nu) + \frac{\beta_0}{4N_c} \chi(n, \nu) \left(-\frac{\chi(n, \nu)}{2} + \frac{5}{3} + \ln \frac{\mu_R^2}{|\vec{p}_{T1}| |\vec{p}_{T2}|} \right) \right\}$$

where

$$Y = y_1 - y_2 = \ln \frac{x_{J1} x_{J2} s}{|\vec{p}_{T1}| |\vec{p}_{T2}|} \quad \text{and} \quad Y_0 = \ln \frac{s_0}{|\vec{p}_{T1}| |\vec{p}_{T2}|}$$

$$\frac{d\sigma}{dy_1 dy_2 d|\vec{p}_{T1}| d|\vec{p}_{T2}|} = \mathcal{C}_0$$

- NLL BFKL contains both renormalization scheme and renormalization scale ambiguities



BFKLP prescription

This is the generalisation of Brodsky-Lepage-Mackenzie (BLM) optimal scale setting procedure [[Phys. Rev. D 28 \(1983\) 229](#)].

Brodsky-Fadin-Kim-Lipatov-Pivovarov (BFKLP) [[JETP Lett. 70 \(1999\) 155-160](#)]

The ambiguity is related to large running coupling effects and non-Abelian nature of the QCD

⇒ one needs to use physical renormalization scheme, in which the non-Abelian contributions presented in the first order, for example physical momentum subtraction scheme (MOM).

MOM and $\overline{\text{MS}}$ schemes are related:

$$\alpha_s^{\overline{\text{MS}}} = \alpha_s^{\text{MOM}} \left(1 + \frac{\alpha_s^{\text{MOM}}}{\pi} (T^\beta + T^{\text{conf}}) \right),$$
$$T^\beta = -\frac{\beta_0}{2} \left(1 + \frac{2}{3} I \right),$$
$$T^{\text{conf}} = \frac{C_A}{8} \left[\frac{17}{2} I + \frac{3}{2} (I - 1) \xi + \left(1 - \frac{1}{3} I \right) \xi^2 - \frac{1}{6} \xi^3 \right], \quad \text{where } I \approx 2.3439, \xi - \text{gauge parameter}$$



BFKLP prescription (2)

Transform to MOM scheme, and separate conformal (β_0 -independent) and non-conformal (β_0 -dependent) parts:

$$\begin{aligned} \mathcal{E}_n^{\text{MOM}} = & \frac{x_{J1}x_{J2}}{|\vec{p}_{T1}||\vec{p}_{T2}|} \int_{-\infty}^{+\infty} d\nu e^{(Y-Y_0)\bar{\alpha}_s^{\text{MOM}}(\mu_R)\chi(n,\nu)} (\alpha_s^{\text{MOM}}(\mu_R))^2 c_1(n,\nu)c_2(n,\nu) \\ & \times \left[1 + \bar{\alpha}_s(\mu_R) \left(\frac{\bar{c}_1^{(1)}(n,\nu)}{c_1(n,\nu)} + \frac{\bar{c}_2^{(1)}(n,\nu)}{c_2(n,\nu)} + \frac{2T^{\text{conf}}}{N_c} + \frac{\beta_0}{2N_c} \left(\frac{5}{3} + \ln \frac{\mu_R^2}{|\vec{p}_{T1}||\vec{p}_{T2}|} - 2 \left(1 + \frac{2}{3}I \right) \right) \right) \right] \\ & + (\bar{\alpha}_s^{\text{MOM}}(\mu_R))^2 \ln \frac{x_{J1}x_{J2}s}{s_0} \left\{ \bar{\chi}(n,\nu) + \frac{T^{\text{conf}}}{N_c} \chi(n,\nu) + \frac{\beta_0}{4N_c} \chi(n,\nu) \left(-\frac{\chi(n,\nu)}{2} + \frac{5}{3} + \ln \frac{\mu_R^2}{|\vec{p}_{T1}||\vec{p}_{T2}|} - 2 \left(1 + \frac{2}{3}I \right) \right) \right\} \Big], \end{aligned}$$

choose μ_R scale so that the non-conformal part vanishes

$$\begin{aligned} \mathcal{E}_n^\beta = & \frac{x_{J1}x_{J2}}{|\vec{p}_{T1}||\vec{p}_{T2}|} \int_{-\infty}^{+\infty} d\nu e^{(Y-Y_0)\bar{\alpha}_s^{\text{MOM}}(\mu^{\text{BFKLP}})\chi(n,\nu)} (\alpha_s^{\text{MOM}}(\mu^{\text{BFKLP}}))^3 c_1(n,\nu)c_2(n,\nu) \\ & \times \frac{\beta_0}{2N_c} \left[\frac{5}{3} + \ln \frac{(\mu^{\text{BFKLP}})^2}{|\vec{p}_{T1}||\vec{p}_{T2}|} - 2 \left(1 + \frac{2}{3}I \right) + \bar{\alpha}_s^{\text{MOM}}(\mu^{\text{BFKLP}}) \ln \frac{x_{J1}x_{J2}s}{s_0} \frac{\chi(n,\nu)}{2} \right. \\ & \left. \times \left(-\frac{\chi(n,\nu)}{2} + \frac{5}{3} + \ln \frac{(\mu^{\text{BFKLP}})^2}{|\vec{p}_{T1}||\vec{p}_{T2}|} - 2 \left(1 + \frac{2}{3}I \right) \right) \right] = 0, \end{aligned}$$